

METAL OXIDE VARISTOR – 05D SERIES

Features

- * Wide operating voltage (V 0.1mA) range from 18V to 750V.
- * Fast responding to transient over-voltage.
- * Large absorbing transient energy capability.
- * Low clamping ratio and no follow-on current.
- * Meets MSL level 1, per J-STD-020 ISO9001-2018
- * Safety number : UL- E317616 VDE-40028836 CQC-12001076477

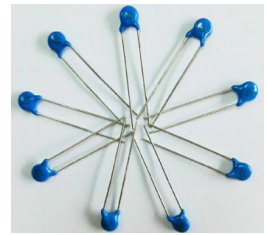

Application

- * Transistor, Diode, IC, Thyristor or Triac semiconductor protection.
- * Surge protection in consumer electronics.
- * Surge protection in industrial electronics.
- * Surge protection in electronic home appliances, gas and petroleum appliances.
- * Relay and electromagnetic valve surge absorption.

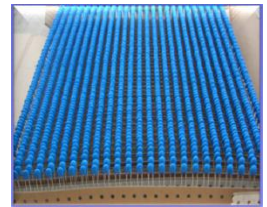

General Characteristics Definition

- * Operating Temperature: (-40 °C ~ +85 °C)
- * Storage Temperature: (-40 °C ~ +125 °C)
- * Working Surface Temperature: +115 °C
- * Insulation Resistance: > 100M Ω
- * Coating (Epoxy Resin): Flame-Retardant to UL 94 V-0



Material

- * Coating: Epoxy Resin
- * Lead Wire: The Copper Wire
- * Electrode: Silver Solder
- * Disk: Zinc Oxide

Part Number Code

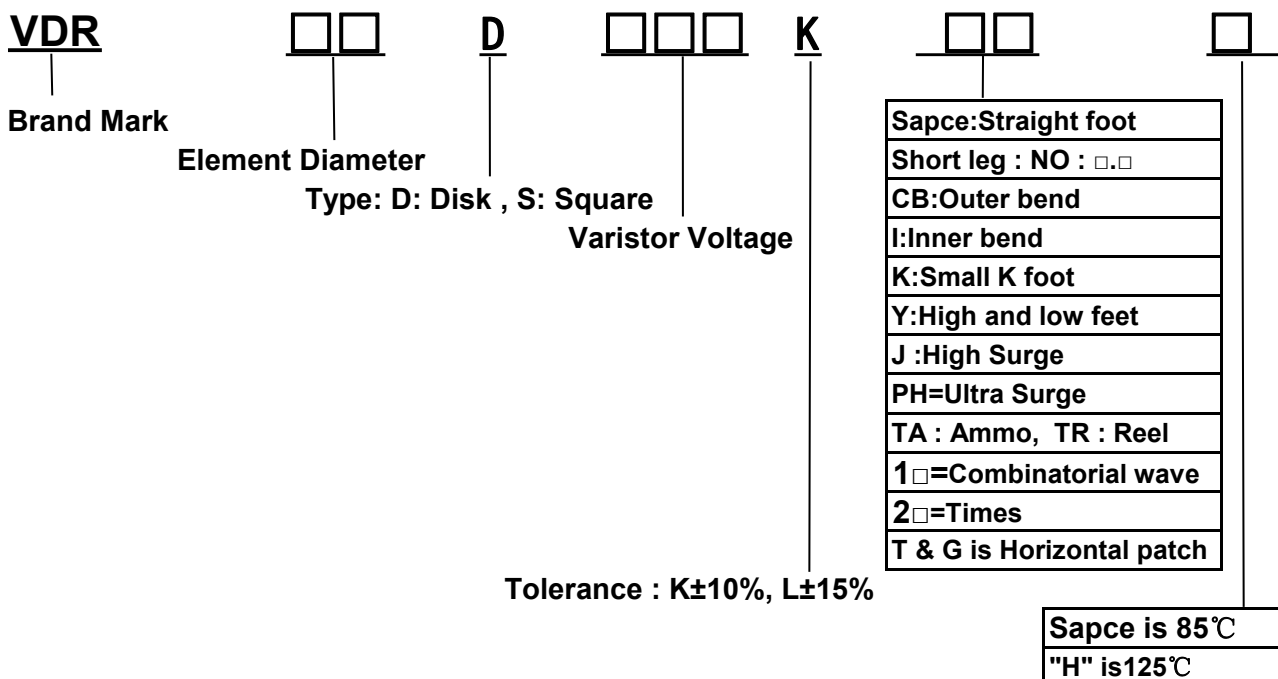



■ Dimensions

S Type(Straight Lead)

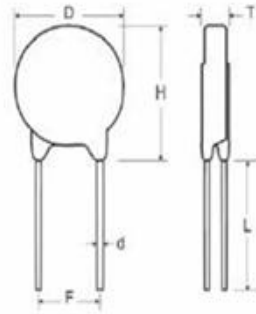

I Type(Inner Crimped Lead)

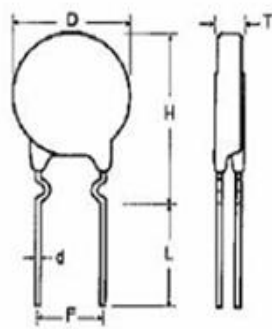

C Type(Out Crimped Lead)

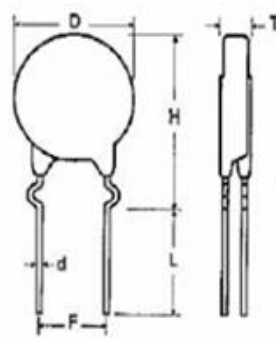

Y Lead Type(Y Kink Lead)

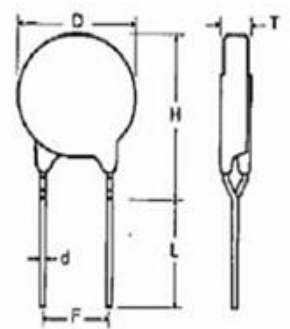

Unit: mm

Part No.	Part No.	T Max.	D Max.	H Max.		L min.	F ±0.8	d ± 0.05
				S	I / C / Y			
VDR-05D180L	VDR-05D180LJ	4.5	7.5	10.5	13.0	20.0	5.0	0.6
VDR-05D220K	VDR-05D220KJ	4.6						
VDR-05D270K	VDR-05D270KJ	4.7						
VDR-05D330K	VDR-05D330KJ	4.9						
VDR-05D390K	VDR-05D390KJ	4.8						
VDR-05D470K	VDR-05D470KJ	4.9						
VDR-05D560K	VDR-05D560KJ	5.0						
VDR-05D680K	VDR-05D680KJ	5.2						
VDR-05D820K	VDR-05D820KJ	4.1						
VDR-05D101K	VDR-05D101KJ	4.3						
VDR-05D121K	VDR-05D121KJ	4.5						
VDR-05D151K	VDR-05D151KJ	4.8						
VDR-05D181K	VDR-05D181KJ	4.3						
VDR-05D201K	VDR-05D201KJ	4.4						
VDR-05D221K	VDR-05D221KJ	4.5						
VDR-05D241K	VDR-05D241KJ	4.6						
VDR-05D271K	VDR-05D271KJ	4.9						
VDR-05D301K	VDR-05D301KJ	5.0						
VDR-05D331K	VDR-05D331KJ	5.1						
VDR-05D361K	VDR-05D361KJ	5.2						
VDR-05D391K	VDR-05D391KJ	5.4						
VDR-05D431K	VDR-05D431KJ	5.7						
VDR-05D471K	VDR-05D471KJ	6.0						
VDR-05D511K	VDR-05D511KJ	6.2						
VDR-05D561K	VDR-05D561KJ	6.5						
VDR-05D621K	VDR-05D621KJ	6.5						
VDR-05D681K	VDR-05D681KJ	6.8						
VDR-05D751K	VDR-05D751KJ	6.9						



ELECTRICAL CHARACTERISTIC

Part Number		Maximum Allowable Voltage		Varistor Voltage	Maximum Clamping Voltage		Withstanding Surge Current		Energy 10/1000 μ S		Rated Power	Typical Capacitance (Reference)
Standard	High Surge	AC (V)	DC (V)	V0.1mA(V)	IP(A)	VC(V)	I(A) Standard	I(A) High Surge	(J) Standard	(J) High Surge	(W)	@1KHzPF
05D180L	05D180LJ	11	14	18(15.3~20.7)	1	40	100	250	0.4	0.6	0.01	1400
05D220K	05D220KJ	14	18	22(19.8~24.2)	1	48	100	250	0.5	0.7	0.01	1150
05D270K	05D270KJ	17	22	27(24.3~29.7)	1	60	100	250	0.6	0.9	0.01	930
05D330K	05D330KJ	20	26	33(29.7~36.3)	1	73	100	250	0.8	1.1	0.01	760
05D390K	05D390KJ	25	31	39(35.1~42.9)	1	80	100	250	0.9	1.2	0.01	640
05D470K	05D470KJ	30	38	47(42.3~51.7)	1	104	100	250	1.1	1.5	0.01	530
05D560K	05D560KJ	35	45	56(50.4~61.6)	1	123	100	250	1.3	1.8	0.01	450
05D680K	05D680KJ	40	56	68(61.2~74.8)	1	145	100	250	1.6	2.2	0.01	370
05D820K	05D820KJ	50	65	82(73.8~90.2)	5	150	400	800	2.5	4.0	0.1	300
05D101K	05D101KJ	60	85	100(90~110)	5	177	400	800	3.0	4.1	0.1	250
05D121K	05D121KJ	75	100	120(108~132)	5	210	400	800	4.0	4.9	0.1	210
05D151K	05D151KJ	95	125	150(135~165)	5	260	400	800	4.1	6.5	0.1	165
05D181K	05D181KJ	115	150	180(162~198)	5	320	400	800	4.9	7.5	0.1	140
05D201K	05D201KJ	130	170	200(185~225)	5	355	400	800	6.5	8.5	0.1	125
05D221K	05D221KJ	140	180	220(198~242)	5	380	400	800	7.5	9.0	0.1	110
05D241K	05D241KJ	150	200	240(216~264)	5	415	400	800	8.0	10.5	0.1	100
05D271K	05D271KJ	175	225	270(243~297)	5	475	400	800	8.5	11.0	0.1	95
05D301K	05D301KJ	190	250	300(270~330)	5	520	400	800	9.0	12.0	0.1	85
05D331K	05D331KJ	210	275	330(297~363)	5	570	400	800	9.5	13.0	0.1	75
05D361K	05D361KJ	230	300	360(324~396)	5	620	400	800	10.0	16.0	0.1	70
05D391K	05D391KJ	250	320	390(351~429)	5	675	400	800	12.0	17.0	0.1	65
05D431K	05D431KJ	275	350	430(387~473)	5	745	400	800	13.0	20.0	0.1	60
05D471K	05D471KJ	300	385	470(423~517)	5	810	400	800	15.0	21.0	0.1	55
05D511K	05D511KJ	320	415	510(459~561)	5	845	400	800	16.0	22.5	0.1	50
05D561K	05D561KJ	350	460	560(504~616)	5	920	400	800	16.5	24.0	0.1	45
05D621K	05D621KJ	385	505	620(558~682)	5	1025	400	800	21.0	25.0	0.1	40
05D681K	05D681KJ	420	560	680(612~748)	5	1120	400	800	22.0	29.0	0.1	35
05D751K	05D751KJ	460	615	750(675~825)	5	1240	400	800	22.4	32.0	0.1	30

05D511K to 05D751K does not have VDE certification



Reliability Test

Mechanical Ratings

Test Parameter	Test Condition / Description			Performance Requirements
Terminal Pull Strength	After gradually applying the load specified below and keeping the unit fixed for ten seconds, the terminal shall be visually examined for any damage.	Diameter	Loading	No visible damage
		0.6mm	1.0 Kg	
		0.8mm	1.0 Kg	
		1.0mm	2.0 Kg	
Terminal Bending Strength	The unit shall be secured with its terminal kept vertical and the weight specified below be applied in the axial direction. The terminal shall gradually be bent by 90° in one direction, then 90° in the opposite direction, and again back to the original position. The damage of the terminal shall be visually examined.	Diameter	Loading	No visible damage
		0.6mm	0.5 Kg	
		0.8mm	0.5 Kg	
		1.0mm	1.0 Kg	
Vibration	The Specimen shall be vibrated by its lead wires with a total amplitude of 1.5mm and a varying frequency of 10~55~10HZ(each minutes) for a period of 2 hours respectively in each X,Y and Z directions.			No visible damage $\Delta VB/VB\% \leq \pm 5\%$
Soldering-solderability	After dipping the terminal to depth of approximately 3mm from the specimen in a soldering bath of 260°C for 10±1(D5: 5±1) seconds. Thereafter the terminal shall be visually examined.			Terminations shall be uniformly tinned
Soldering-Resistance to Solder Heat	After preheating the specimen, the specimen shall be completely immersed into a soldering bath having a temperature of 260±5°C for 10±1 (D5: 5±1) seconds or iron of 400±5°C for 3±0.5 seconds. There after the change of Vb and mechanical damage shall be examined.			No visible damage $\Delta VB/VB\% \leq \pm 5\%$

ENVIRONMENTAL RATINGS

Dry Heat Loading	The specimen shall be applied continuously the maximum allowable voltage at the specified conditions for specified period and then stored at room temperature and normal humidity over 2 hours. Thereafter, the change of Vb and mechanical damage shall be examined. temp : 125±2°C ; Period : 1000±24hours.			$\Delta VB/VB\% \leq \pm 10\%$	
High Temperature Storage	In a drying oven without load. Ambient temp : 125±2°C ; period : 1000±24hours			$\Delta VB/VB\% \leq \pm 5\%$	
Damp Heat Loading	The specimen shall be applied continuously the maximum allowable voltage at the specified conditions for specified period and then stored at room temperature and normal humidity over 2 hours. Thereafter, the change of Vb and mechanical damage shall be examined. condition : 40±2°C , 90 to 95%R.H. ; period : 1000±24 hours			$\Delta VB/VB\% \leq \pm 10\%$	
Temperature Cycle	Condition the specimen to each temperature form step 1 to step 4 in this order for the period shown in the table of specifications. The change of Vb and mechanical damage shall be examined after 2 hours.	Step	Temp°C	Period	No visible damage $\Delta VB/VB\% \leq \pm 10\%$
		1	-40±3°C	30 min.	
		2	Room Temp	15 min.	
		3	85±2°C	30 min.	
		4	Room Temp	15 min.	
Surge Lifetime Rating	The change of Vb shall be measured after the impulse listed below is applied 10,000 times continuously with the interval of ten seconds at room temperature.			No visible damage $\Delta VB/VB\% \leq \pm 10\%$	
Voltage Proof	Voltage : 2500VAC Leakage Current ≤ 0.5mA Time : 60 Seconds			No Breakdown	

MARKING CODE

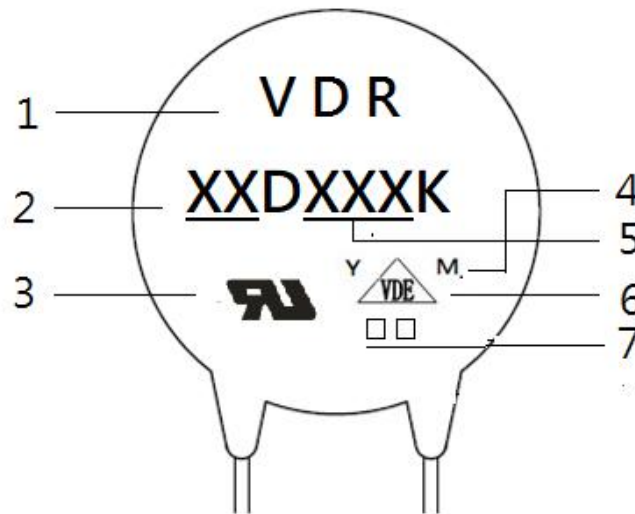

- 1 Logo
- 2 Disk Size
- 3 CUL Accreditation Logo
- 4 “Y” & “M” Product Line Code
- 5 Varistor Voltage
- 6 VDE Accreditation Logo
- 7 “J” is High Surge Code, not “J” is Standard Surge
“H” is High temperature range , not “H” is Standard

Packaging specification / bulk packaging quantity

Unit:Pcs

Dimension	Part No.	Bag	Small Carton	Carton
05D	180L to 821K	1,000	10,000	20,000
05D (Short leg)	180L to 821K	1,000	15,000	30,000

Taping and Dimensions (05D)

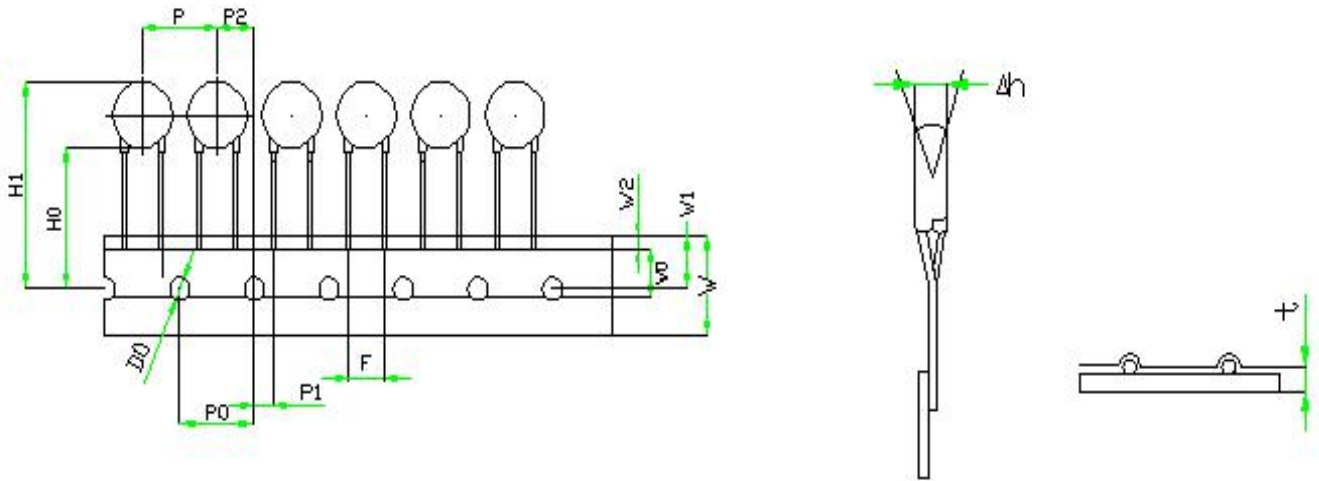

ITEM.	P	P0	P1	P2	F	Δh	W	W0	W1	W2	H1	H0	Do	t
ToL.	12.7	12.7	3.85	6.35	5	0	18	8	9	3	29	20	4	0.6
Nor.	±1.0	±0.3	±0.5	±1.3	±0.8	±0.5	±0.8	±1.0	±0.5	Max	Max	±1.0	±0.2	±0.3

(Unit:mm)

Packaging

■ **Reel Packing**

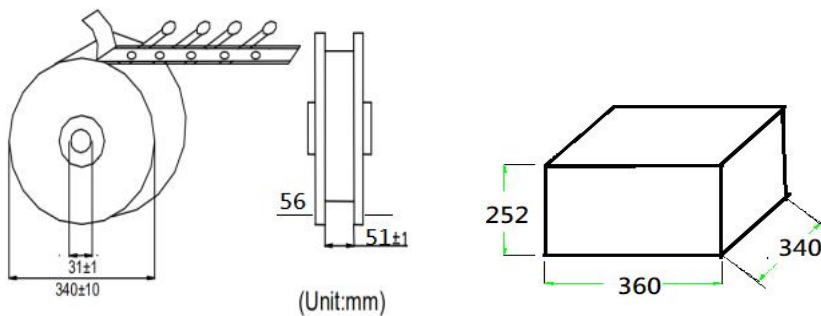

4 Reels/ Carton

Disc Size/mm	pcs/reel
Φ 05/07(180~391)	1500
Φ 05/07(431~821)	1000
Φ 10(180~391)	1000
Φ 10(431~911)	750
Φ 10(102~112)	500
Φ 14(180~391)	750
Φ 14(431~112)	500
Φ 20(180~681)	500
Φ 20(751~112)	250

■ **Ammo Packing**

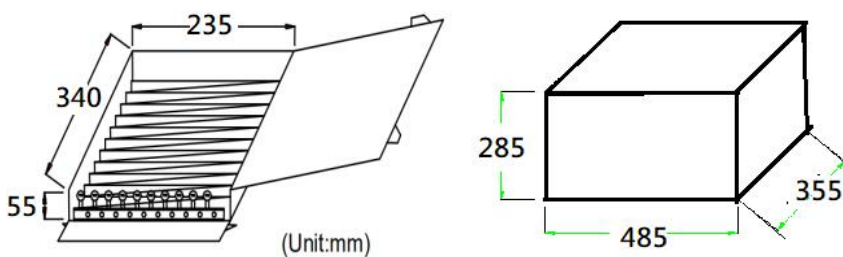

10 Boxes/Carton

Disc Size/mm	pcs/ box
Φ 05/07(180~821)	1000
Φ 10(181~361)	750
Φ 10(391~621)	400
Φ 10(681~112)	300
Φ 14(181~271)	500
Φ 14(301~112)	250