

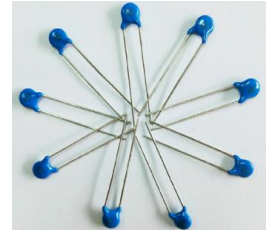

METAL OXIDE VARISTOR – 07D SERIES

Features

- * Wide operating voltage (V1mA) range from 18V to 820V.
- * Fast responding to transient over-voltage.
- * Large absorbing transient energy capability.
- * Low clamping ratio and no follow-on current.
- * Meets MSL level 1, per J-STD-020 ISO9001-2018
- * Safety number :  E317616 VDE-40028836 CQC-12001076478



Application

- * Transistor, Diode, IC, Thyristor or Triac semiconductor protection.
- * Surge protection in consumer electronics.
- * Surge protection in industrial electronics.
- * Surge protection in electronic home appliances, gas and petroleum appliances.
- * Relay and electromagnetic valve surge absorption.

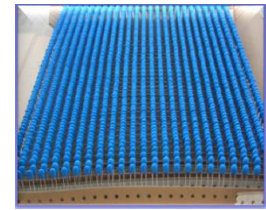

General Characteristics Definition

- * Operating Temperature: (-40 °C ~+85 °C) & (-40 °C ~+125 °C)
- * Storage Temperature: (-40 °C ~ +125 °C)
- * Working Surface Temperature: +115 °C
- * Insulation Resistance: > 100M Ω
- * Coating (Epoxy Resin): Flame-Retardant to UL 94 V-0



Material

- * Coating: Epoxy Resin
- * Lead Wire: The Copper Wire
- * Electrode: Silver Solder
- * Disk: Zinc Oxide

Part Number Code

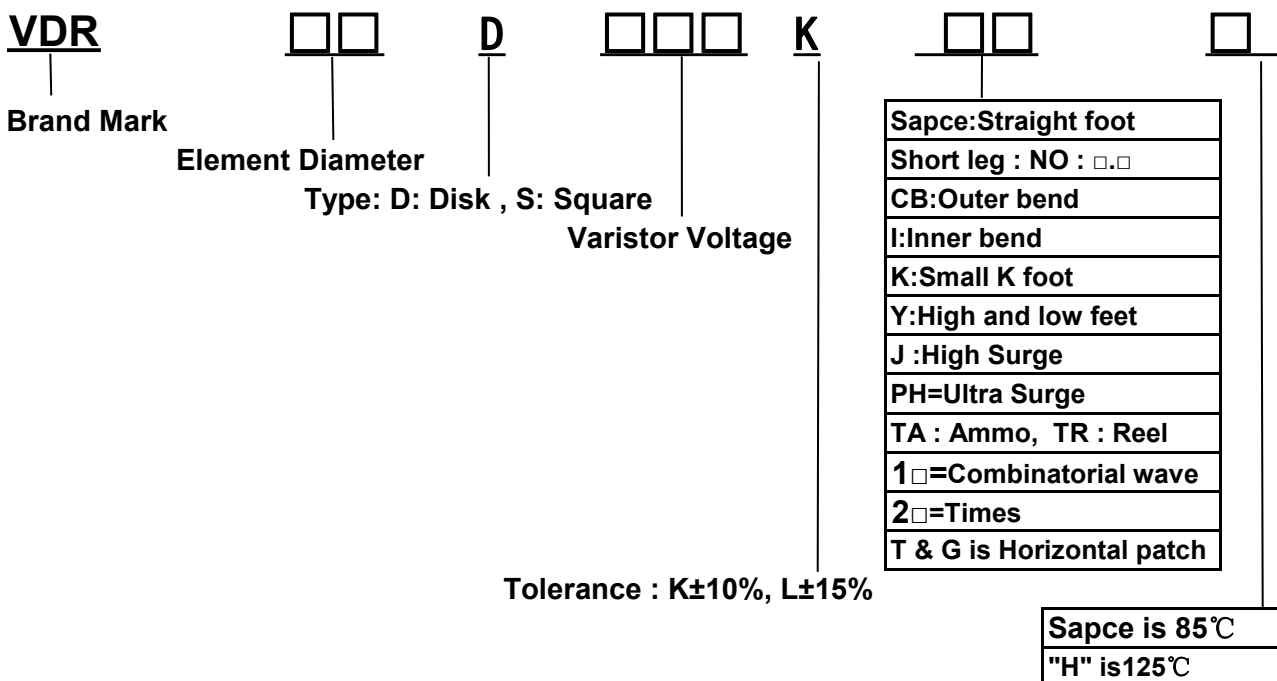



■ Dimensions

S Type(Straight Lead)

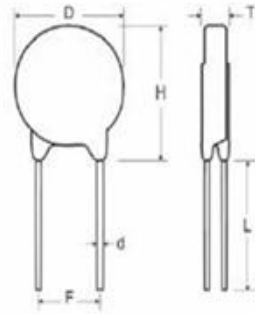

I Type(Inner Crimped Lead)

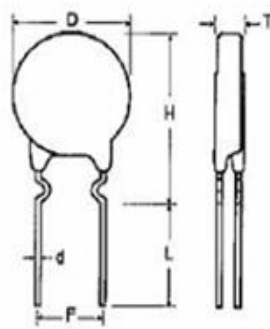

C Type(Out Crimped Lead)

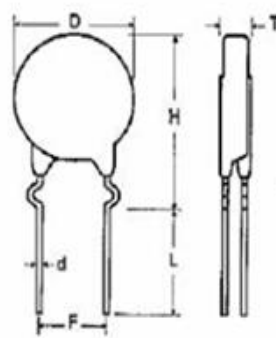

Y Lead Type(Y Kink Lead)

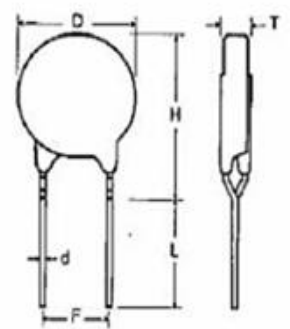

Unit: mm

Part No.	Part No.	T Max.	D Max.	H Max.		L min.	F ±0.8	d ± 0.05
				S	I / C / Y			
VDR-07D180L	VDR-07D180LJ	4.5	9.0	11.0	14.0	20.0	5.0	0.6
VDR-07D220K	VDR-07D220KJ	4.6						
VDR-07D270K	VDR-07D270KJ	4.7						
VDR-07D330K	VDR-07D330KJ	4.9						
VDR-07D390K	VDR-07D390KJ	4.9						
VDR-07D470K	VDR-07D470KJ	4.9						
VDR-07D560K	VDR-07D560KJ	5.0						
VDR-07D680K	VDR-07D680KJ	5.2						
VDR-07D820K	VDR-07D820KJ	4.1						
VDR-07D101K	VDR-07D101KJ	4.3						
VDR-07D121K	VDR-07D121KJ	4.5						
VDR-07D151K	VDR-07D151KJ	4.8						
VDR-07D181K	VDR-07D181KJ	4.3						
VDR-07D201K	VDR-07D201KJ	4.4						
VDR-07D221K	VDR-07D221KJ	4.5						
VDR-07D241K	VDR-07D241KJ	4.6						
VDR-07D271K	VDR-07D271KJ	4.9						
VDR-07D301K	VDR-07D301KJ	5.0						
VDR-07D331K	VDR-07D331KJ	5.1						
VDR-07D361K	VDR-07D361KJ	5.2						
VDR-07D391K	VDR-07D391KJ	5.4						
VDR-07D431K	VDR-07D431KJ	5.7						
VDR-07D471K	VDR-07D471KJ	6.0						
VDR-07D511K	VDR-07D511KJ	6.2						
VDR-07D561K	VDR-07D561KJ	6.5						
VDR-07D621K	VDR-07D621KJ	7.1						
VDR-07D681K	VDR-07D681KJ	7.3						
VDR-07D751K	VDR-07D751KJ	7.5						
VDR-07D781K	VDR-07D781KJ	7.7						
VDR-07D821K	VDR-07D821KJ	8.0						



ELECTRICAL CHARACTERISTIC

Part Number		Maximum Allowable Voltage		Varistor Voltage	Maximum Clamping Voltage		Withstanding Surge Current		Energy 10/1000 μ S		Rated Power	Typical Capacitance (Reference)
Standard	High Surge	AC (V)	DC (V)	V1mA(V)	IP(A)	VC(V)	I(A) Standard	I(A) High Surge	(J) Standard	(J) High Surge	(W)	@1KHzPF
07D180L	07D180LJ	11	14	18(15.3~20.7)	2.5	36	250	500	0.9	2.0	0.02	2800
07D220K	07D220KJ	14	18	22(19.8~24.2)	2.5	43	250	500	1.1	2.4	0.02	2300
07D270K	07D270KJ	17	22	27(24.3~29.7)	2.5	53	250	500	1.4	3.0	0.02	1800
07D330K	07D330KJ	20	26	33(29.7~36.3)	2.5	65	250	500	1.7	3.5	0.02	1500
07D390K	07D390KJ	25	31	39(35.1~42.9)	2.5	77	250	500	2.1	4.0	0.02	1300
07D470K	07D470KJ	30	38	47(42.3~51.7)	2.5	93	250	500	2.5	5.0	0.02	1100
07D560K	07D560KJ	35	45	56(50.4~61.6)	2.5	110	250	500	3.1	6.0	0.02	890
07D680K	07D680KJ	40	56	68(61.2~74.8)	2.5	135	250	500	3.6	7.0	0.02	740
07D820K	07D820KJ	50	65	82(73.8~90.2)	10	135	1200	1750	5.5	10	0.25	600
07D101K	07D101KJ	60	85	100(90~110)	10	165	1200	1750	6.5	12	0.25	500
07D121K	07D121KJ	75	100	120(108~132)	10	200	1200	1750	7.8	12	0.25	420
07D151K	07D151KJ	95	125	150(135~165)	10	250	1200	1750	9.7	13	0.25	330
07D181K	07D181KJ	115	150	180(162~198)	10	300	1200	1750	11.7	16	0.25	280
07D201K	07D201KJ	130	170	200(185~225)	10	330	1200	1750	13	17	0.25	250
07D221K	07D221KJ	140	180	220(198~242)	10	360	1200	1750	14	19	0.25	230
07D241K	07D241KJ	150	200	240(216~264)	10	395	1200	1750	15	21	0.25	210
07D271K	07D271KJ	175	225	270(243~297)	10	455	1200	1750	18	24	0.25	185
07D301K	07D301KJ	190	250	300(270~330)	10	505	1200	1750	20	26	0.25	165
07D331K	07D331KJ	210	275	330(297~363)	10	550	1200	1750	23	28	0.25	150
07D361K	07D361KJ	230	300	360(324~396)	10	595	1200	1750	25	32	0.25	140
07D391K	07D391KJ	250	320	390(351~429)	10	650	1200	1750	25	35	0.25	130
07D431K	07D431KJ	275	350	430(387~473)	10	710	1200	1750	28	40	0.25	115
07D471K	07D471KJ	300	385	470(423~517)	10	775	1200	1750	30	42	0.25	105
07D511K	07D511KJ	320	415	510(459~561)	10	845	1200	1750	30	45	0.25	100
07D561K	07D561KJ	350	460	560(504~616)	10	920	1200	1750	30	49	0.25	90
07D621K	07D621KJ	385	505	620(558~682)	10	1025	1200	1750	33	55	0.25	80
07D681K	07D681KJ	420	560	680(612~748)	10	1120	1200	1750	33	60	0.25	75
07D751K	07D751KJ	460	615	750(675~825)	10	1240	1200	1750	65	67	0.25	70
07D781K	07D781KJ	485	640	780(702~858)	10	1290	1200	1750	65	67	0.25	70
07D821K	07D821KJ	510	670	820(738~902)	10	1355	1200	1750	65	70	0.25	60



Reliability Test

Mechanical Ratings

Test Parameter	Test Condition / Description			Performance Requirements
Terminal Pull Strength	After gradually applying the load specified below and keeping the unit fixed for ten seconds, the terminal shall be visually examined for any damage.	Diameter	Loading	No visible damage
		0.6mm	1.0 Kg	
		0.8mm	1.0 Kg	
		1.0mm	2.0 Kg	
Terminal Bending Strength	The unit shall be secured with its terminal kept vertical and the weight specified below be applied in the axial direction. The terminal shall gradually be bent by 90° in one direction, then 90° in the opposite direction, and again back to the original position. The damage of the terminal shall be visually examined.	Diameter	Loading	No visible damage
		0.6mm	0.5 Kg	
		0.8mm	0.5 Kg	
		1.0mm	1.0 Kg	
Vibration	The Specimen shall be vibrated by its lead wires with a total amplitude of 1.5mm and a varying frequency of 10~55~10HZ(each minutes) for a period of 2 hours respectively in each X,Y and Z directions.			No visible damage $\Delta VB/VB\% \leq \pm 5\%$
Soldering-solderability	After dipping the terminal to depth of approximately 3mm from the specimen in a soldering bath of 260°C for 10±1(D5: 5±1) seconds. Thereafter the terminal shall be visually examined.			Terminations shall be uniformly tinned
Soldering-Resistance to Solder Heat	After preheating the specimen, the specimen shall be completely immersed into a soldering bath having a temperature of 260±5°C for 10±1 (D5: 5±1) seconds or iron of 400±5°C for 3±0.5 seconds. There after the change of Vb and mechanical damage shall be examined.			No visible damage $\Delta VB/VB\% \leq \pm 5\%$

ENVIRONMENTAL RATINGS

Dry Heat Loading	The specimen shall be applied continuously the maximum allowable voltage at the specified conditions for specified period and then stored at room temperature and normal humidity over 2 hours. Thereafter, the change of Vb and mechanical damage shall be examined. temp : 125±2°C ; Period : 1000±24hours.			$\Delta VB/VB\% \leq \pm 10\%$	
High Temperature Storage	In a drying oven without load. Ambient temp : 125±2°C ; period : 1000±24hours			$\Delta VB/VB\% \leq \pm 5\%$	
Damp Heat Loading	The specimen shall be applied continuously the maximum allowable voltage at the specified conditions for specified period and then stored at room temperature and normal humidity over 2 hours. Thereafter, the change of Vb and mechanical damage shall be examined. condition : 40±2°C , 90 to 95%R.H. ; period : 1000±24 hours			$\Delta VB/VB\% \leq \pm 10\%$	
Temperature Cycle	Condition the specimen to each temperature form step 1 to step 4 in this order for the period shown in the table of specifications. The change of Vb and mechanical damage shall be examined after 2 hours.	Step	Temp°C	Period	No visible damage $\Delta VB/VB\% \leq \pm 10\%$
		1	-40±3°C	30 min.	
		2	Room Temp	15 min.	
		3	85±2°C	30 min.	
		4	Room Temp	15 min.	
Surge Lifetime Rating	The change of Vb shall be measured after the impulse listed below is applied 10,000 times continuously with the interval of ten seconds at room temperature.			No visible damage $\Delta VB/VB\% \leq \pm 10\%$	
Voltage Proof	Voltage : 2500VAC Leakage Current ≤ 0.5mA Time : 60 Seconds			No Breakdown	

MARKING CODE

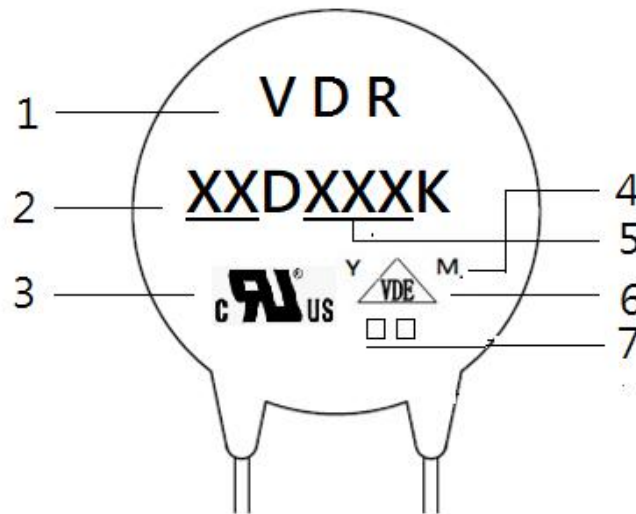

- 1 Logo
- 2 Disk Size
- 3  Accreditation Logo
- 4 “Y” & “M” Product Line Code
- 5 Varistor Voltage
- 6 VDE Accreditation Logo
- 7 “J” is High Surge Code, not “J” is Standard Surge
“H” is High temperature range, not “H” is Standard

Packaging specification / bulk packaging quantity

Unit:Pcs

Dimension	Part No.	Bag	Small Carton	Carton
07D	180L to 821K	1,000	10,000	20,000
07D (Short leg)	180L to 821K	1,000	15,000	30,000

Taping and Dimensions (07D)

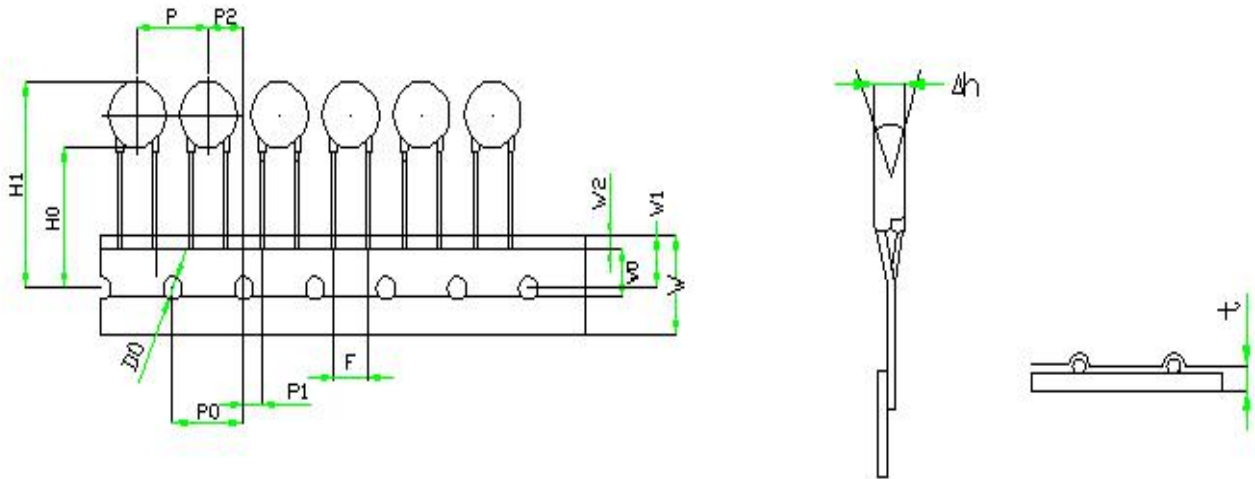

ITEM.	P	P0	P1	P2	F	Δh	W	W0	W1	W2	H1	H0	Do	t
ToL.	12.7	12.7	3.85	6.35	5	0	18	8	9	3	32	20	4	0.6
Nor.	±1.0	±0.3	±0.5	±1.3	±0.8	±0.5	±0.8	±1.0	±0.5	Max	Max	±1.0	±0.2	±0.3

(Unit:mm)

Packaging

■ Reel Packing

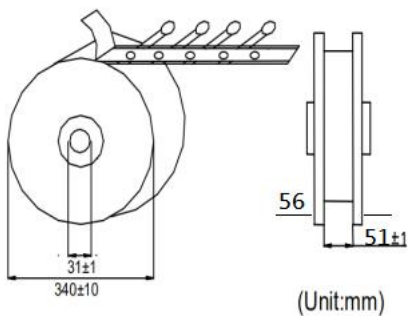

(Unit:mm)

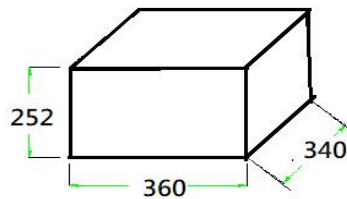

Disc Size/mm	pcs/reel
Φ 05/07(180~391)	1500
Φ 05/07(431~821)	1000
Φ 10(180~391)	1000
Φ 10(431~911)	750
Φ 10(102~112)	500
Φ 14(180~391)	750
Φ 14(431~112)	500
Φ 20(180~681)	500
Φ 20(751~112)	250

4 Reels/ Carton

■ Ammo Packing

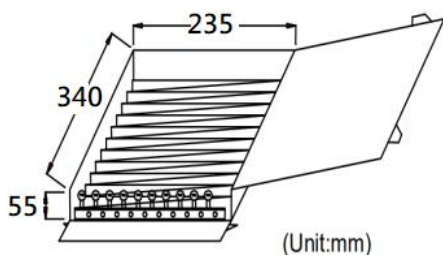

(Unit:mm)

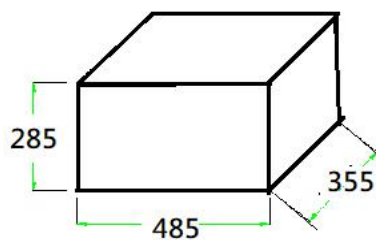

Disc Size/mm	pcs/ box
Φ 05/07(180~821)	1000
Φ 10(181~361)	750
Φ 10(391~621)	400
Φ 10(681~112)	300
Φ 14(181~271)	500
Φ 14(301~112)	250

10 Boxes/Carton